

# *Illusions*<sup>®</sup> Vinyl Fence

The Classic Face of the American Landscape

Beautify Your Outdoor Living Space • Enjoy Stylish Privacy & Security  
Increase Your Property Value • 100% Pure Virgin Vinyl Fence



# Why Illusions Vinyl Fence?

**Because Your Home Deserves the Very Best!**



**You've done everything in your power to make your home fit your unique style.**

*Why would you settle for less from your fence?*

You wouldn't. That's why Illusions Vinyl Fence is the perfect fit for your next fence installation. It's got everything you need all rolled up into a simple and affordable package.

As a part of the Eastern Fence Family with locations throughout the east coast, we have been manufacturing and distributing fence and railing products for almost 50 years. Your possibilities are endless when you choose your Illusions products.

Designed with the sole purpose of allowing your creativity to flow, Illusions Vinyl Fence allows you to Mix 'n' Match your color options to create unique variations to match your home or business.

***To find out more information, check out the website: [illusionsfence.com](http://illusionsfence.com)***



[www.illusionsfence.com](http://www.illusionsfence.com)



# Why Illusions Vinyl Fence?



## ASTM F964-13 Compliant

ASTM F964-13 is considered the most recognized testing specification for vinyl. The purpose of this specification is to establish a recognized standard of quality for exterior vinyl profiles for use in assembling agricultural, commercial, and residential fencing and railing.



## QuickShip™ InStock NO-WAIT Program

**Got an important party coming up and need a fence quick?**

Many styles of Illusions Vinyl Fence and their matching 4' and 5' wide gates are in stock and available for immediate shipment. Ask your fence installer for information on all current options.



## Ready to Specify

Illusions Vinyl Fence styles are available on [www.CADDetails.com](http://www.CADDetails.com) to help you immediately specify for commercial and residential installations. Spec sheets, CAD files, PDFs, and more are ready to help you get your Illusions Fence installed today!



## Made in the U.S.A.

Manufactured by Eastern Wholesale Fence, Illusions Vinyl Fence has been a household name in the fence industry for almost 30 years and is proudly manufactured in the United States of America.



## Warranty

**The best looking products in the industry give you a great warranty as well!**

Classic Illusions Fence is protected by a comprehensive limited lifetime warranty. For details and warranty related questions, please visit the Illusions fence website at [www.illusionsfence.com](http://www.illusionsfence.com).



[www.illusionsfence.com](http://www.illusionsfence.com)



# PRIVACY



CLASSIC WHITE V3215DS-6

Privacy Panels feature a “V”-Jointed tongue and groove board and come with a wide variety of decorative tops. Privacy fence panels include a metal reinforcement channel in the bottom rail to help create a stronger and longer lasting fence. We pride ourselves on offering a Privacy Panel for every taste.

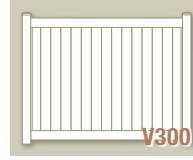

V300

PRIVACY

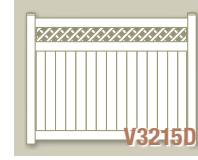

V3215D

PRIVACY WITH  
DIAGONAL LATTICE

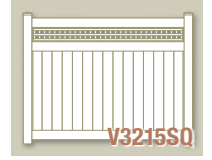

V3215SQ

PRIVACY WITH  
SQUARE LATTICE

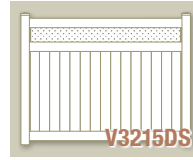

V3215DS

PRIVACY WITH  
SMALL DIAGONAL  
LATTICE

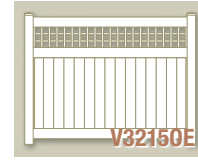

V32150E

PRIVACY WITH OLD  
ENGLISH LATTICE

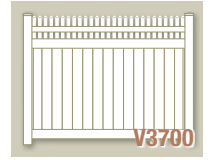

V3700

PRIVACY WITH  
STRAIGHT  
PICKET TOP

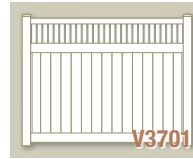

V3701

PRIVACY WITH  
FRAMED  
PICKET TOP

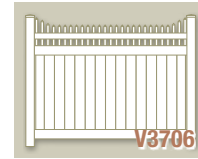

V3706

PRIVACY WITH  
STEPPED  
PICKET TOP



V3707

PRIVACY WITH  
SCALLOPED  
PICKET TOP



V300-6 IN CLASSIC BEIGE AND CLASSIC CLAY

# PRIVACY



V3215D-6 IN CLASSIC GRAY AND CLASSIC WHITE



V3700-6 IN CLASSIC WHITE



V300-6 IN CLASSIC WHITE WITH VBG4 GATE WITH SQUARE LATTICE



V300-6 IN CLASSIC BEIGE AND CLASSIC WHITE WITH CLASSIC WHITE VARGG ARBOR WITH SQUARE LATTICE

# SEMI-PRIVACY



HORIZONTAL SEMI-PRIVACY  
WITH 3" BOARDS



V5706-6 IN CLASSIC WHITE

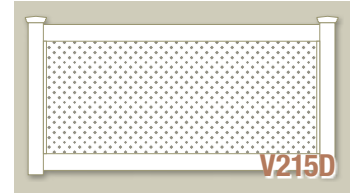

SMALL DIAGONAL LATTICE

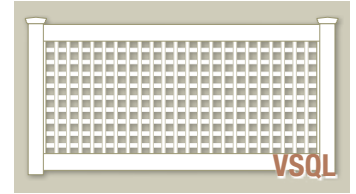

OLD ENGLISH LATTICE

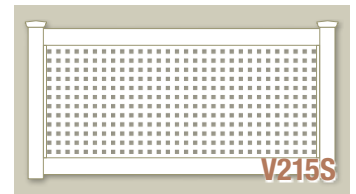

SQUARE LATTICE

The Illusions Vinyl Fence Semi-Privacy line has one of the largest selections offered and is specially designed for basic privacy without a "closed in" feeling. This extensive selection offers standard semi-privacy styles with space between the boards to allow air to flow through as well as the well known Board-on-Board styles with overlapping boards that provide both privacy and airflow.

Also popular in the Semi-Privacy series is "Old English Lattice." It's designed to look like a vinyl version of the common fence style used for growing vines, gardens, and hedgerows. Semi-Privacy fence panels include a metal reinforcement channel in the bottom rail to help create a stronger and longer lasting fence. Available in all Classic Colors.

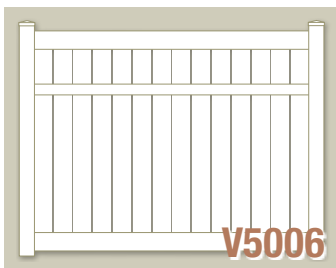

V5006  
SEMI-PRIVACY WITH 6" BOARDS

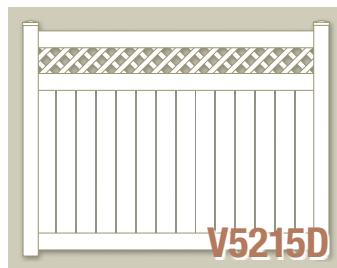

V5215D  
SEMI-PRIVACY WITH 6" BOARDS  
AND DIAGONAL LATTICE

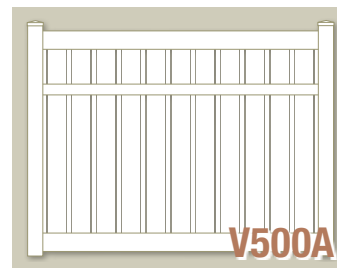

V500A  
SEMI-PRIVACY WITH ALTERNATING  
6" AND 1-1/2" BOARDS

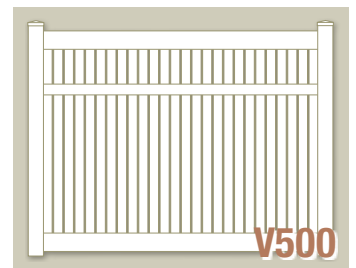

V500  
SEMI-PRIVACY WITH 3" BOARDS

## Board-On-Board Styles Use V300 or V500 Series Gates

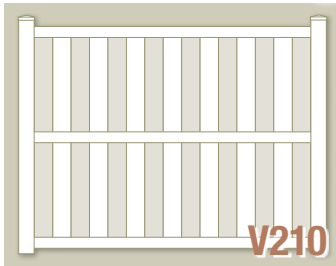

V210  
BOARD ON BOARD

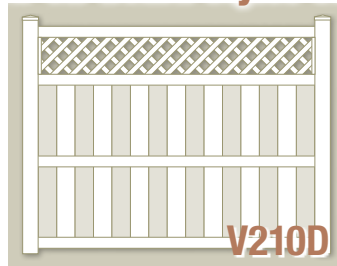

V210D  
BOARD ON BOARD WITH  
DIAGONAL LATTICE

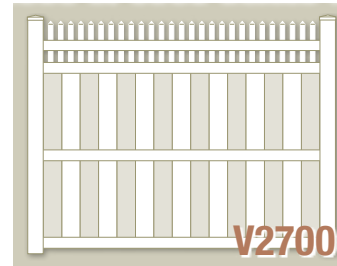

V2700  
BOARD ON BOARD WITH  
STRAIGHT PICKET TOP

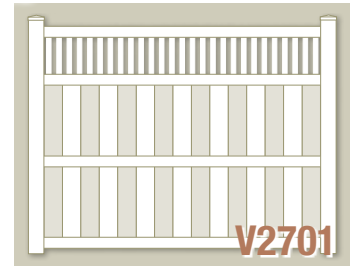

V2701  
BOARD ON BOARD WITH  
FRAMED PICKET TOP

# CLASSIC VICTORIAN PICKET



V707-4 IN CLASSIC WHITE

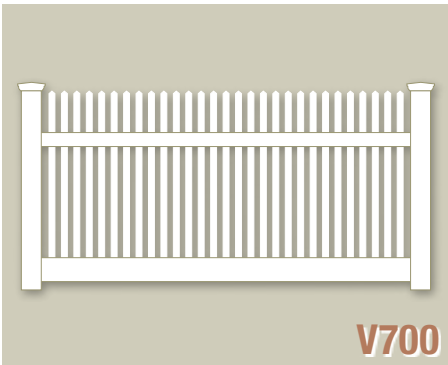

1-1/2" X 1-1/2" STRAIGHT TOP PICKET

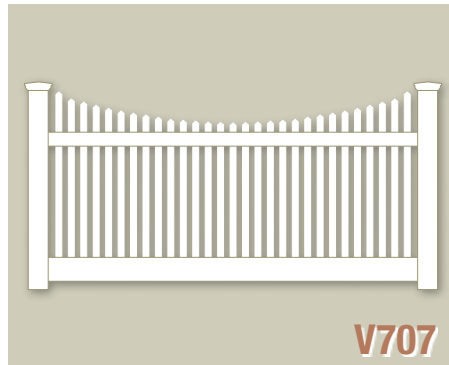

1-1/2" X 1-1/2" SCALLOPED PICKET

One of the most popular fence styles in the USA is the Illusions Vinyl Fence Classic Victorian Picket.

Using 1-1/2" x 1-1/2" pickets, it is a maintenance-free look alike of the old red cedar fence. All of the panels are carefully designed with the classic look in mind and are available in all Classic Colors.

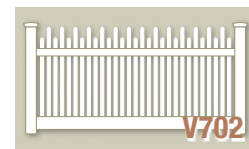

1-1/2" X 1-1/2" STAGGERED TOP PICKET

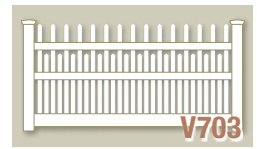

1-1/2" X 1-1/2" STAGGERED PICKET

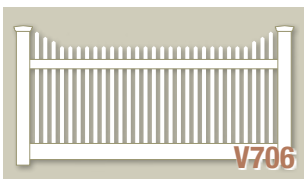

1-1/2" X 1-1/2" STEPPED TOP PICKET

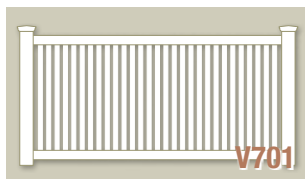

1-1/2" X 1-1/2" FRAMED TOP PICKET

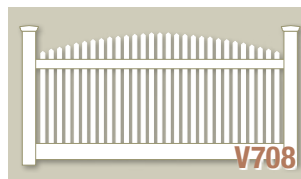

1-1/2" X 1-1/2" ARCHED TOP PICKET

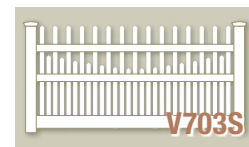

1-1/2" X 1-1/2" STAGGERED SCALLOPED PICKET



1-1/2" X 1-1/2" FRAMED STAGGERED PICKET

# CONTEMPORARY PICKET



V352-4 IN CLASSIC WHITE



7/8" X 3" PICKETS WITH DOG-EAR PICKET CAPS



7/8" X 3" ARCHED PICKETS W/ DOG-EAR PICKET CAPS



7/8" X 3" PICKETS W/ POINTED PICKET CAPS



7/8" X 3" SCALLOPED PICKETS W/ POINTED PICKET CAPS



7/8" X 3" STEPPED PICKETS W/ POINTED PICKET CAPS



7/8" X 3" PICKETS WITH POINTED PICKET CAPS (REDUCED SPACING)

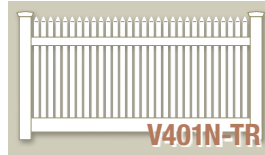

7/8" X 1-1/2" PICKETS W/ POINTED PICKET CAPS

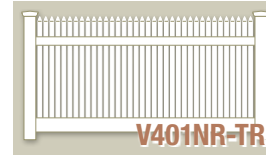

7/8" X 1-1/2" PICKETS W/ POINTED PICKET CAPS (REDUCED SPACING)

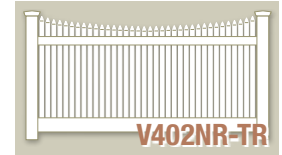

7/8" X 1-1/2" SCALLOPED W/ POINTED PICKET CAPS (REDUCED SPACING)

Illusions Contemporary Picket Fence offers what is known as the "good neighbor" approach to fencing. It is a fence that features both sides of the panels being exactly the same. The pickets are assembled THROUGH the rails instead of simply being attached to them. Available in all Classic Colors.

# ORNAMENTAL PICKET



V0200-4 WITH BOY SCOUT PICKET TOPS IN CLASSIC BEIGE AND CLASSIC WHITE

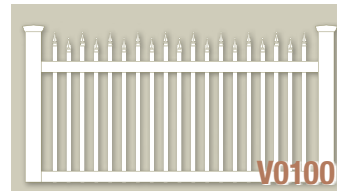

1" X 1" ORNAMENTAL PICKET FENCE WITH STAGGERED PICKET TOPS

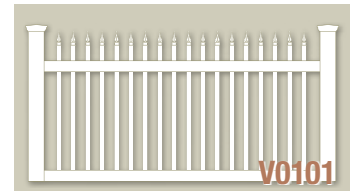

1" X 1" ORNAMENTAL PICKET FENCE WITH STRAIGHT PICKET TOP

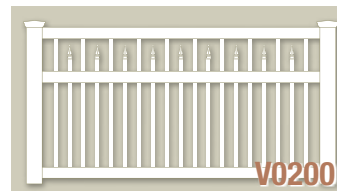

1" X 1" ORNAMENTAL PICKET FENCE WITH STAGGERED FRAMED PICKET TOP

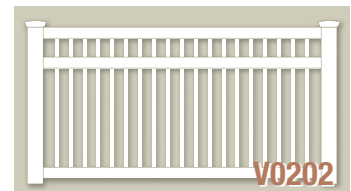

1" X 1" FRAMED TOP ORNAMENTAL PICKET FENCE

Illusions Ornamental 1" x 1" Picket is a vinyl alternative to the wrought iron fence. It enables you to maintain the look of wrought iron without the maintenance. Available in all Classic Colors.

## PICKET TOP STYLES



ARROWHEAD



BOY SCOUT



GOthic

# POST & RAIL



**3-RAIL POST & RAIL IN CLASSIC BEIGE**

Illusions Post & Rail fence is available with three different styled rails for the Two-Rail, Three-Rail, Four-Rail or Crossbuck fence. Whatever setting you may have, Illusions has the look you want and the strength you need.



**2-RAIL**



**3-RAIL**

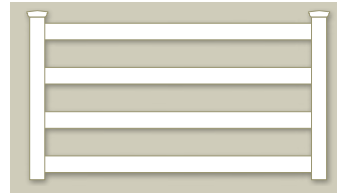

**4-RAIL**

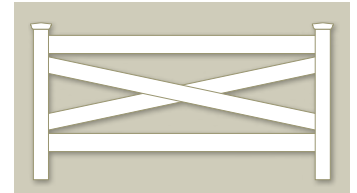

**CROSSBUCK**



**2-RAIL DIAMOND**

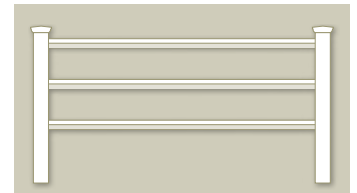

**3-RAIL DIAMOND**

# RAILING



**VRT6 3 IN CLASSIC CLAY**

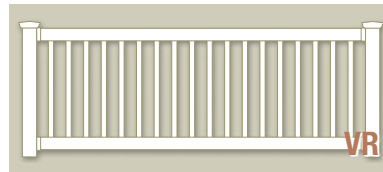

**TRADITIONAL - 2" X 3.5" TOP-RAIL**

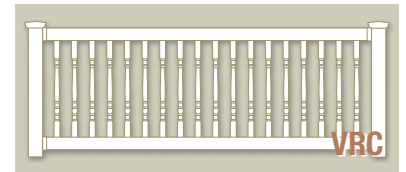

**COLONIAL - 2" X 3.5" TOP-RAIL**

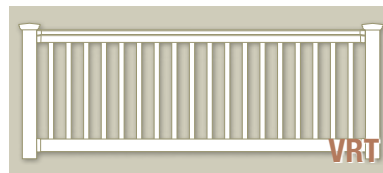

**TRADITIONAL - T-RAIL TOP-RAIL**

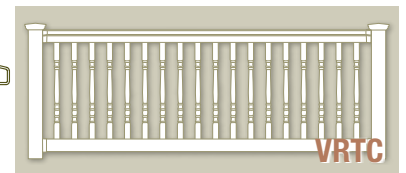

**COLONIAL - T-RAIL TOP-RAIL**

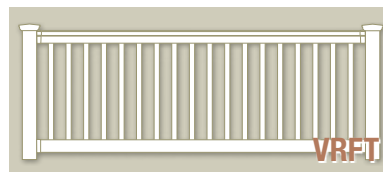

**TRADITIONAL - FLAT T-RAIL TOP-RAIL**

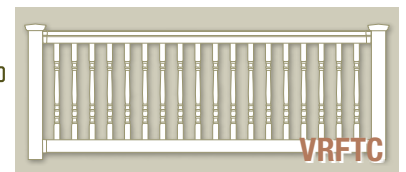

**COLONIAL - FLAT T-RAIL TOP-RAIL**

Illusions offers a complete line of vinyl railings. All Illusions Vinyl Railing System railing panels contain a metal channel in the top-rail. Illusions Vinyl Railings also offers an *optional* metal channel for the bottom rail for extra protection.

See page 27 for more information on Illusions Vinyl Railings.

# CURVES & TRANSITIONS

## Simple to Order Matching Accessories for Your Illusions Vinyl Fence

Enhance the look and feel of your Illusions Vinyl Fence with these readily available curved and bent rails. Perfect for unique fence styles, transition sections, or for rounded corners of your property. All rails are available in all Classic Color options.

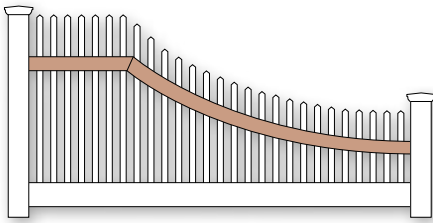

**WATERFALL "A" SLOPE RAIL**

Available in ALL fence styles

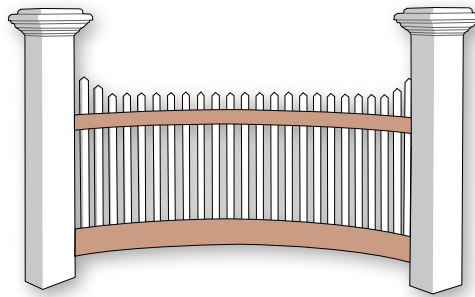

**RADIUS "E" RAIL**

Only available in picket fence styles

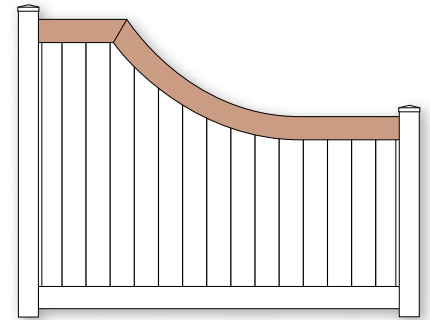

**WATERFALL "H" RAIL**

Available in all full privacy and Semi-privacy fence styles

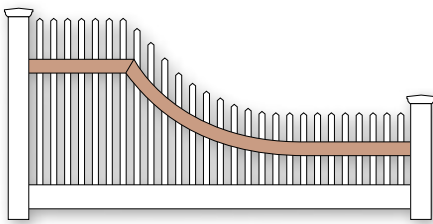

**WATERFALL "B" SWEEP RAIL**

Available in ALL fence styles

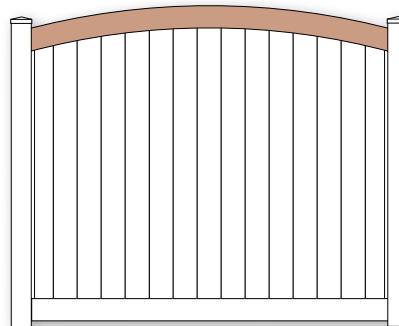

**CROWNED "F" RAIL**

Available in all full privacy and Semi-privacy fence styles

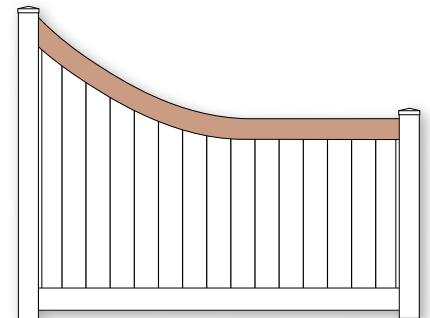

**SWEEP "I" RAIL**

Available in all full privacy and Semi-privacy fence styles

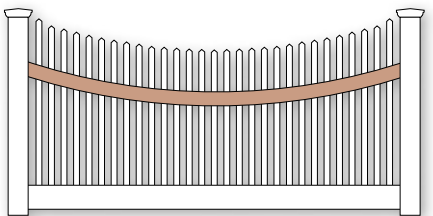

**SCALLOPED "C" RAIL**

Available in ALL fence styles

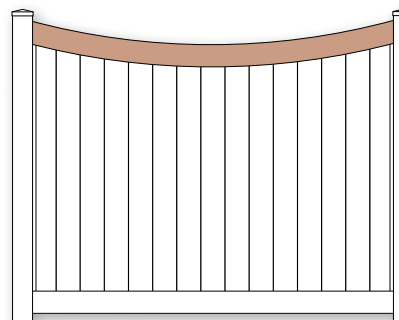

**SCALLOPED "G" RAIL**

Available in all full privacy and Semi-privacy fence styles

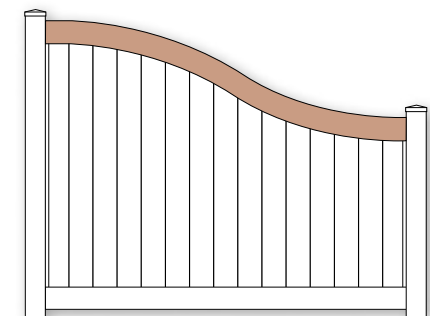

**S-CURVED STYLED "J" RAIL**

Available in all full privacy and Semi-privacy fence styles

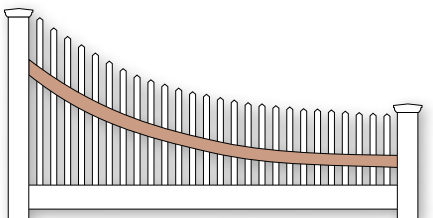

**SWEEP "D" RAIL**

Available in ALL fence styles

# CURVES & TRANSITIONS

## Simple to Order Matching Accessories for Your Illusions Vinyl Fence

Transition sections are used when you need to change the height of a fence run.  
 Perfect for backyard to front yard height adjustments, ending sections, corner accents, and more!  
 All rails are available in all Classic Color options.

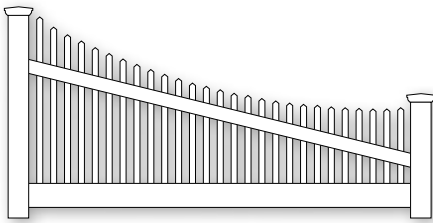

**SW-A (Sweep Pickets / Angled Rail)**  
 Available in all picket fence styles

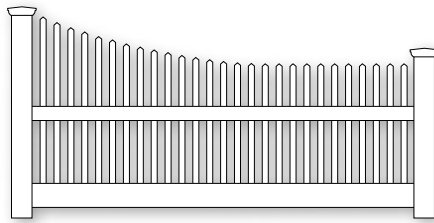

**SW-S (Sweep Pickets / Straight Rail)**  
 Available in all picket fence styles

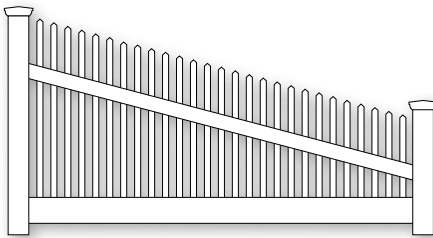

**TAP-A (Tapered Pickets / Angled Rail)**  
 Available in all picket fence styles

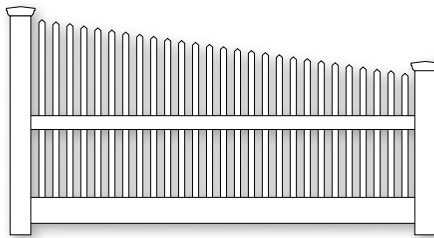

**TAP-S (Tapered Pickets / Straight Rail)**  
 Available in all picket fence styles

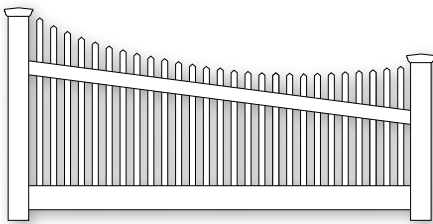

**SCAL-A (Scalloped Pickets / Angled Rail)**  
 Available in all picket fence styles

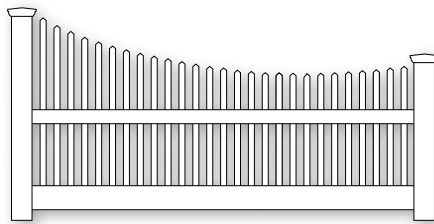

**SCAL-S (Scalloped Pickets / Straight Rail)**  
 Available in all picket fence styles

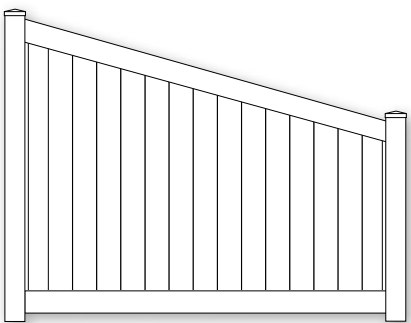

**TAPER (Straight Taper)**  
 Available in all privacy and Semi-privacy styles

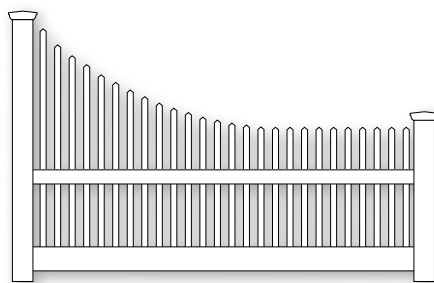

**SL-S (Sloped Pickets / Straight Rail)**  
 Available in all picket fence styles



### TRANSITION "J" RAILS

Illusions Classic V3215DS section with a transition s-curved "J" Rail top and mid-rails. Shown in Classic Gray and White.



### "D" - RAIL

VBD300 Illusions Classic V300 section with a curved "D" Rail style transition top rail. Shown in Classic White.

# MATCHING WELDED GATES

(Matching Assembled Gates Available  
Ask Your Fence Installer for More Information)

## PRIVACY

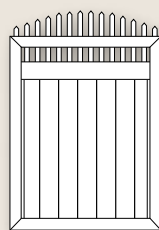
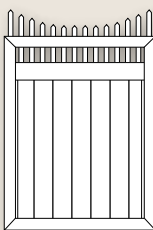
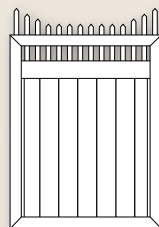
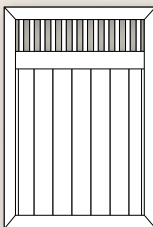
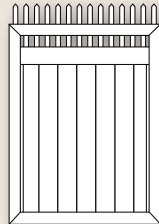
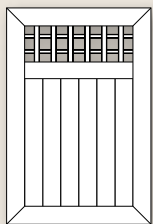
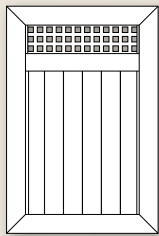
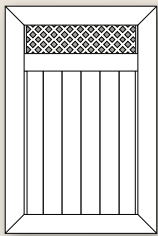
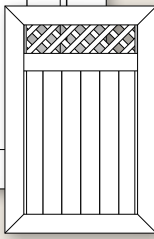
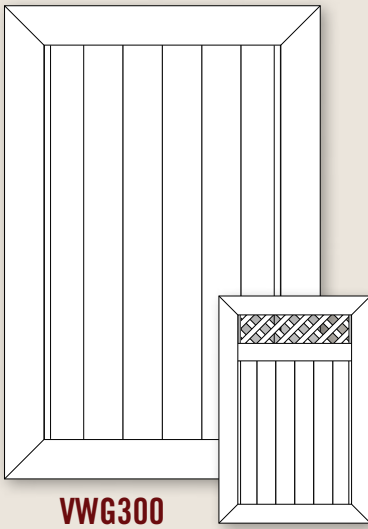

## SEMI-PRIVACY

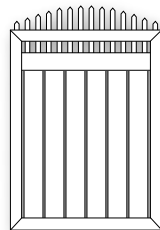
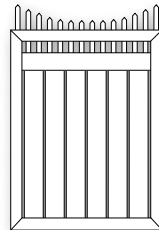
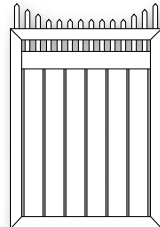
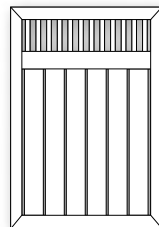
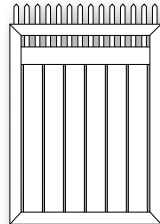
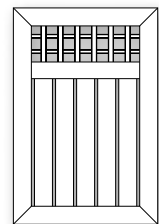
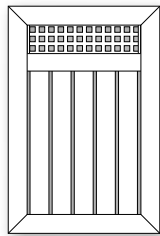
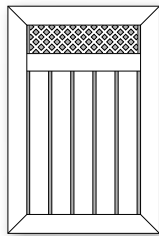
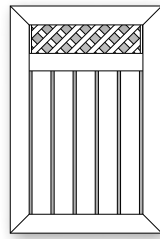
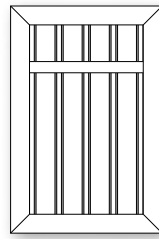
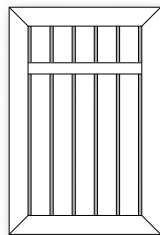
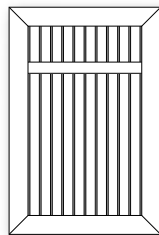

## BOARD-ON-BOARD

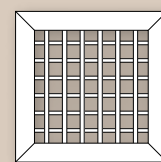
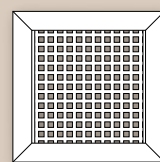
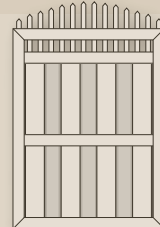

## CLASSIC VICT. PICKET

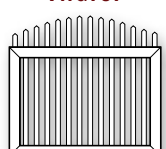
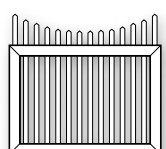
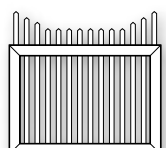
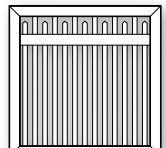
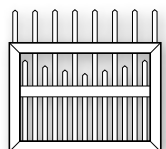
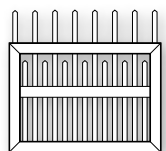
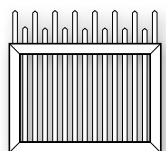
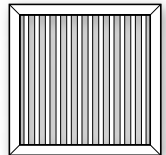
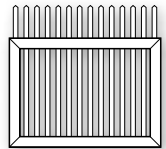

B-o-B  
Styles  
Use  
V300  
or  
V500  
Series  
Gates

## LATTICE

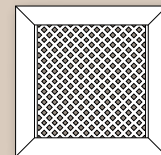

# MATCHING WELDED GATES

(Matching Assembled Gates Available  
Ask Your Fence Installer for More Information)

Standard 3' & 4' Width Walk Gates (VWG), and 5' & 6' Width Drive Gates (VDG) (Custom Sizes and Styles Available)

## ACCENT GATES

### CONTEMPORARY PICKET

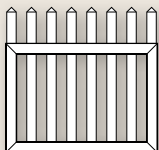

VWG401-TR

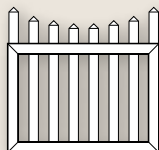

VWG402-TR

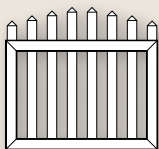

VWG403-TR

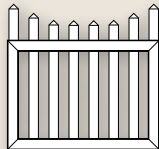

VWG406-TR

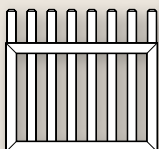

VWG350-TR

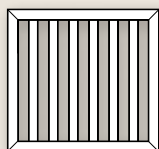

VWG351-TR

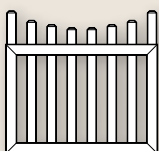

VWG352-TR

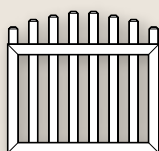

VWG353-TR

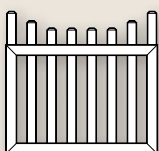

VWG356-TR

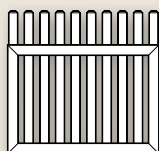

VWG353R-TR

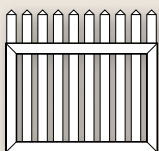

VWG401R-TR

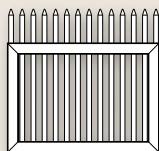

VWG401N-TR

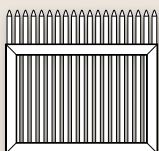

VWG401NR-TR

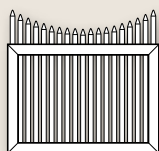

VWG402NR-TR

### ORNAMENTAL PICKET

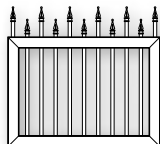

VWG0100

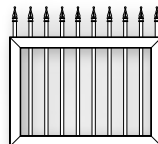

VWG0101

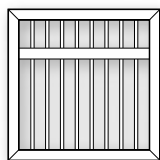

VWG0202

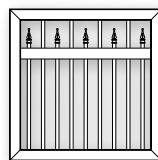

VWG0200

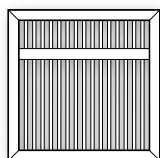

VWG0402

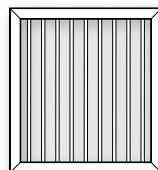

VWGOV52

### POST AND RAIL



V2RWG

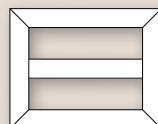

V3RWG

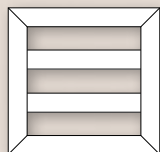

V4RWG

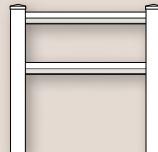

VDRG-42

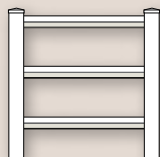

VDRG-43

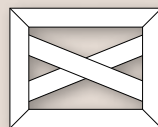

VWGCB

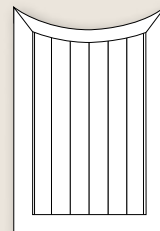

VBG1

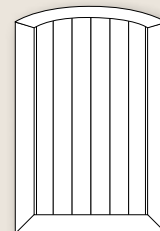

VBG2

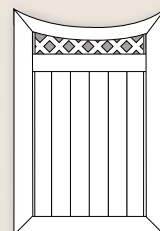

VBG3

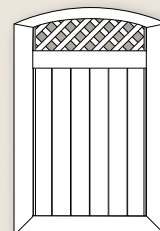

VBG4

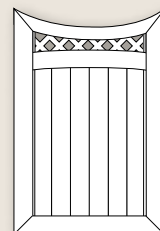

VBG5

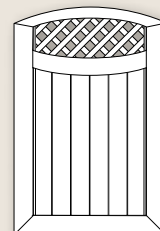

VBG6

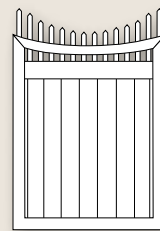

VBG7

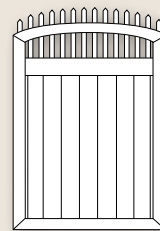

VBG8

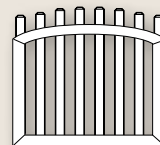

VBG10

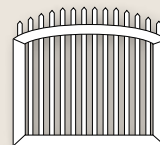

VBG11

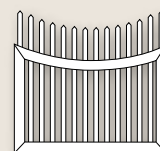

VBG12

**NEW!**



ASSEMBLED GATES FOR SELECT STYLES

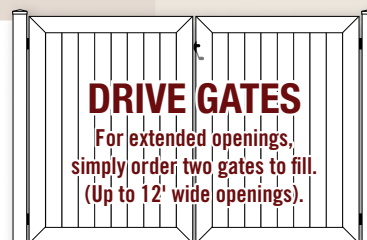

### DRIVE GATES

For extended openings,  
simply order two gates to fill.  
(Up to 12' wide openings).

(Shown: Two 5' Wide VDG300-56)

# ARBORS & PERGOLAS

Illusions Arbors & Pergolas are an important option to help add flair to your fence installation by taking it from a good looking fence install to a great looking fence install in one simple step. Use with a gate or as a fun ornament for your landscaping.

AVAILABLE  
IN  
ALL  
CLASSIC  
COLOR  
OPTIONS!

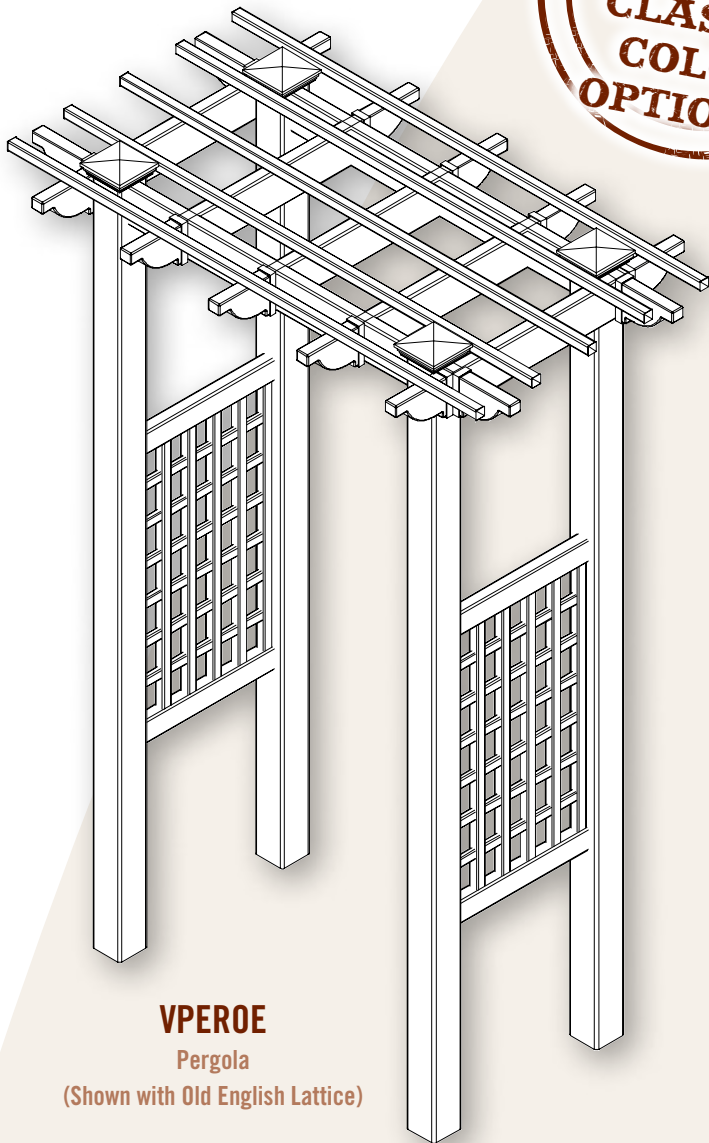

**VPEROE**  
Pergola  
(Shown with Old English Lattice)

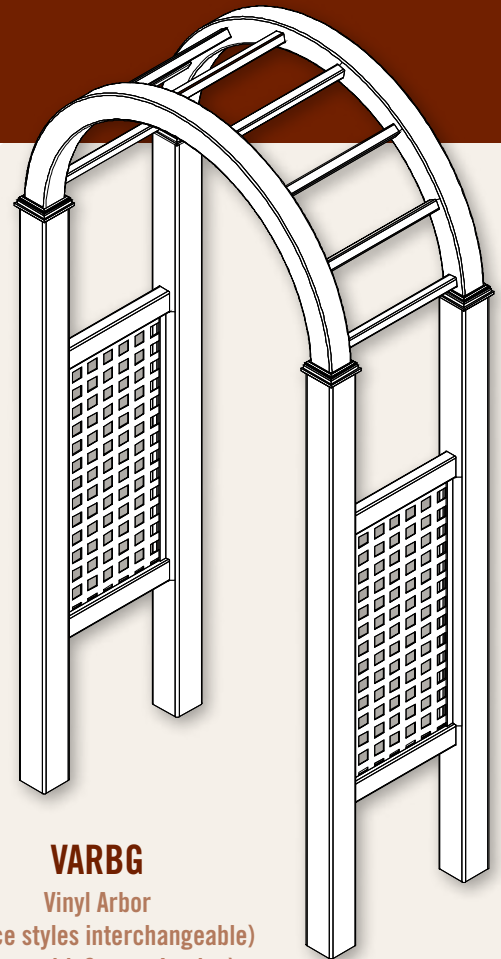

**VARBG**  
Vinyl Arbor  
(Lattice styles interchangeable)  
(Shown with Square Lattice)

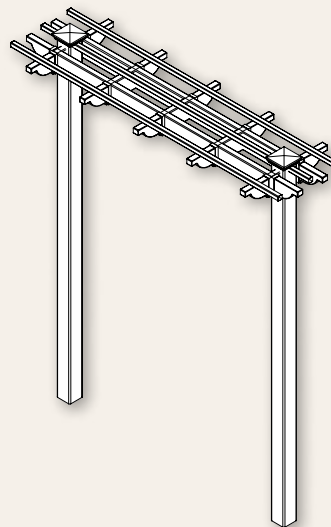

**VPER2P**  
2 Post Pergola

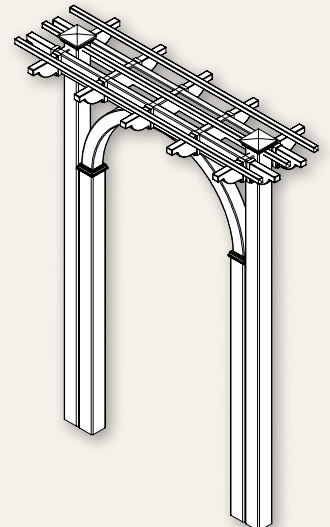

**VPER4P**  
4 Post Pergola with Arch

# ARBORS & PERGOLAS



V3707-6 6' high privacy fence with scalloped Classic Victorian Picket top and matching VWG3707-46 walk gate and VPEROE pergola with Old English Lattice. All shown in Classic Clay and Classic White.



VPER2P



VARBG (Diagonal Lattice)



VARBG (Small Diagonal Lattice)



VPER4P

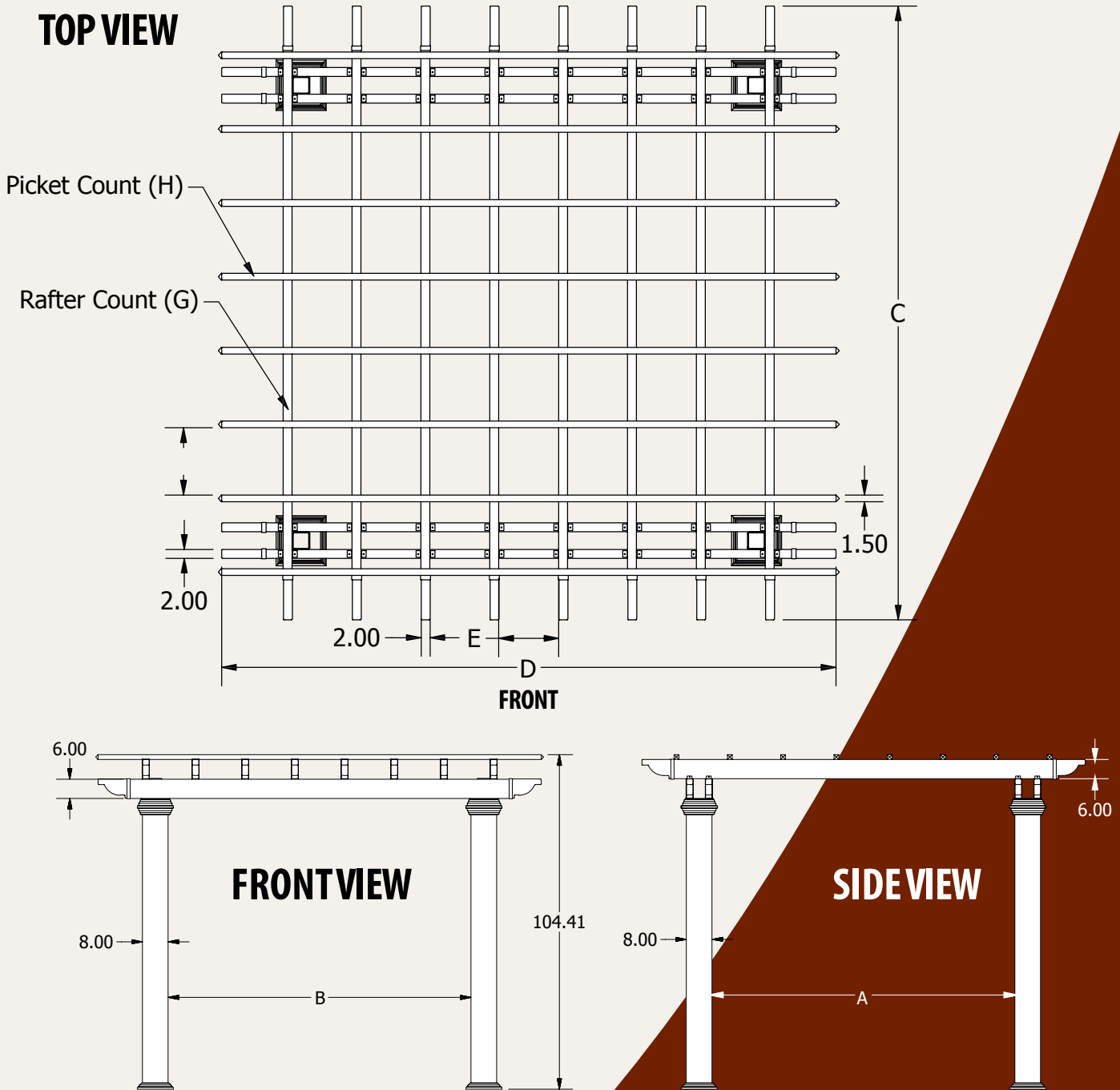

Measurement	A	B	C	D	E	F	G	H
Kit Size	Inches	Inches	Inches	Inches	Inches	Inches	Pieces	Pieces
8' x 8'	70"	70"	114.2"	114.2"	12"	13.95"	7	7
8' x 12'	70"	118.75"	114.2"	162.2"	12.75"	13.95"	10	7
10' x 10'	94.5"	94.5"	138.2"	138.2"	13.5"	15.171"	8	8
10' x 12'	94.5"	118.75"	138.2"	162.2"	12.75"	15.171"	10	8
12' x 12'	118.75"	118.75"	162.2"	162.2"	12.75"	16.088"	10	9

# PERGOLA KITS



**AVAILABLE  
IN  
ALL CLASSIC  
COLOR  
OPTIONS!**

Perfect for any setting, Illusions Pergola Kits can be installed both inground or surface mount.

Item #	Description
VPK88	8' x 8' Vinyl Pergola Kit (Inground)
VPK1010	10' x 10' Vinyl Pergola Kit (Inground)
VPK1212	12' x 12' Vinyl Pergola Kit (Inground)
VPK812	8' x 12' Vinyl Pergola Kit (Inground)
VPK1012	10' x 12' Vinyl Pergola Kit (Inground)
VPKM88	8' x 8' Vinyl Pergola Kit with Post Inserts (Surface Mount)
VPKM1010	10' x 10' Vinyl Pergola Kit with Post Inserts (Surface Mount)
VPKM1212	12' x 12' Vinyl Pergola Kit with Post Inserts (Surface Mount)
VPKM812	8' x 12' Vinyl Pergola Kit with Post Inserts (Surface Mount)
VPKM1012	10' x 12' Vinyl Pergola Kit with Post Inserts (Surface Mount)

Surface Mount Kits include all items necessary for fabrication EXCEPT fasteners



# LOW VOLTAGE LIGHTING

## Low Voltage Fence, Railing, & Deck Lighting Solutions

Illusions Vinyl Fence Low Voltage Lighting Caps and Hardware are made to combine safety and quality with aesthetics. Lighting is one way that customers can add a unique touch to their deck, fence, or railing. Illusions lighting products are constructed with only high grade, commercial components.

Illusions Low Voltage Lighting was created to provide contractors and homeowners LED lighting solutions that are easy to install, reliable, and affordable.

These attractive lighting components will increase the enjoyment of any outdoor living space while also adding ambiance and safety.

- Simple and Easy to Install
- No wires to cut - plug together wiring harness
- Single power supply for all lights
- No need for an electrician or electrical permits
- Weather resistant connectors and lights
- Long-lasting LED's
- Housings are durable and UV stable
- Low voltage DC power supply
- Dusk to dawn light sensor
- Available with remote dimmer switch



### VNPCL55W

5" Neptune Halo LV Post Cap - White  
0.80 Watts

Also available in 4"  
VNPCL44W



0.80 Watts

### VHPCL44W

4" Halo LV Light - White



0.80 Watts

### VDPCL44W

4" Downward LV Post Cap - White



0.80 Watts

### VCPC44W

4" Combo LV Post Cap Light



0.80 Watts

### VLDOMEW

LV Dome Side Light - Scalloped Lens



0.40 Watts

### VLSTW

LV Side/Stair Light (Comes with 2 Covers)



0.40 Watts

### VLSIDEW

Ornamental LV Side Light

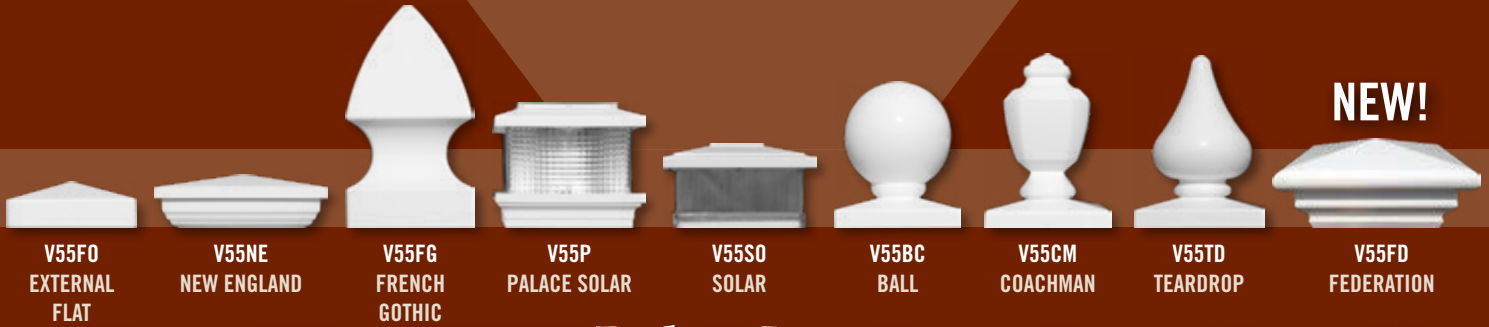

**NEW!**

## Picket Caps

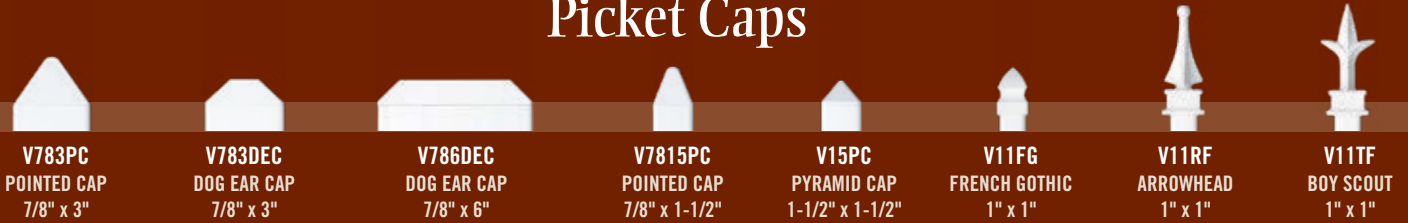

# HARDWARE

## Hinges

All Illusions Gate Hardware is custom designed to our specifications and manufactured using only the highest quality materials held to the same rigorous standards we use for all of our products. Many of our products are available in black, white, and bronze. Use a Vinyl Gate Stopper (VGS or VGSH) on all gates and two sets of Drop Rods (DRAS) on double drive gates.

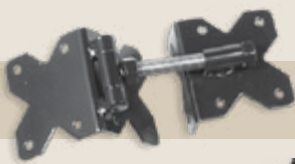

**CPH55**  
CORNER PLATE HINGE  
(Black or White)  
(Sold in pairs)



**CPH55S**  
SPRING LOADED CORNER  
PLATE HINGE  
(Black, White, or Bronze)  
(Sold in pairs)



**THSL**  
TRUE-CLOSE  
SPRING HINGE  
(Black Only)  
(Sold in pairs)



**THAHD-BK**  
ADJUSTABLE TRUE-CLOSE  
SPRING HINGE  
(Black or White)  
(Sold in pairs)



**IESH**  
X-TRA STRONG HINGE  
(Black or White)  
(Sold in pairs)

## Latches



**MLDD-BK**  
MAGNETIC GATE LATCHES  
(Black or White)



**MLS-BK**  
SMALL MAGNETIC GATE  
LATCHES  
(Black or White)

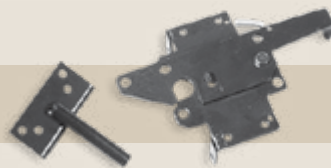

**HLSS**  
STAINLESS STEEL  
HATCHET LATCH  
(Black, White, or Bronze)



**V21SS**  
STAINLESS STEEL GRAVITY  
LATCH W/PLATE  
(Black, White, or Bronze)



**V21LL**  
GRAVITY LATCH  
KEYED 2-SIDES  
(Black or White)

## Misc.



**DRAS OR DRAS48**  
24" OR 48" DROP ROD  
(Black or White)  
(Bronze Also for 24")



**VGSH**  
GATE STOP/HANDLE COMBO  
(Black or White)



**VHDL**  
GATE HANDLE  
(Black, White, or Bronze)



**VGS**  
PVC GATE STOP  
(Black or White)



**CSB-12SS**  
STAINLESS STEEL SPRING CLOSER  
(Black or White)

NOTE: Items on this page are not to scale.

# COLOR OPTIONS

## Classic Series

Looking for something simple and timeless?

Check out your 4 Illusions "Classic" color options. White, Beige, Gray, and Clay.



**CLASSIC WHITE**



**CLASSIC BEIGE**



**CLASSIC GRAY**

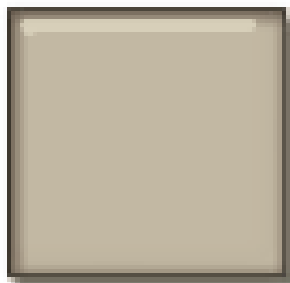

**CLASSIC CLAY**

ALL COLORS SHOWN ARE APPROXIMATE. SEE PHYSICAL SAMPLE FOR ACTUAL COLOR.



**QuickShip** V300-6CL  
6' Height Tongue and Groove panels with 7/8" x 6" boards, 1-1/2" x 5-1/2" top and bottom horizontal rails, a metal reinforcement channel in the bottom rail, and 7/8" x 1" U-Channel edgings to add a unique and attractive aesthetic. Shown in the color Classic Clay.



All Classic Series Colors Are Available in V300-6 **QuickShip**<sup>™</sup>  
For other styles and colors that are in stock all the time, just look for the **QuickShip** logo.

# Fence Specifications



## WHAT IS ASTM F964-13?

### Scope

ASTM F964-13 is considered the “end all, beat all” testing specification for vinyl fence. The purpose of this specification is to establish a recognized standard of quality for exterior vinyl profiles for use in assembling agricultural, commercial, and residential fencing and railing. This specification covers Illusions Vinyl Fence sections and the EverStrong Profiles® used to fabricate them.

### Materials

Illusions Vinyl Fence Products are manufactured using Rigid Poly Vinyl Chloride (PVC) compounds for exterior-profile extrusions that meet the requirements of ASTM Specification D4216.

### Manufacture

Illusions Vinyl Fence Products are manufactured to meet cell Class 1–21333–22 as defined in Specification D4216. Illusions compounds have higher cell classification because one or more properties are superior to those used in standard acceptable compounds.

**Color/Consistency Testing** – The PVC compound in extruded section shall maintain uniform color and be free of any visual surface or structural changes, such as peeling, chipping, cracking, flaking, or pitting after weathering at intervals of six months and one year for white and for six months, one year, and two years for all other colors in hot, dry climate such as Phoenix, AZ; a hot humid climate, such as Miami, FL; and a temperate northern climate, when tested in accordance with ASTM Performance Weathering Requirements (TABLE 1).

**Weathering Testing** – The PVC compound shall have a minimum impact resistance of 0.6 in.-lb/mil (2670 J/m) after weathering six months and one year in a hot, dry climate such as Phoenix, AZ; a hot, humid climate, such as Miami, FL; and a temperate northern climate, when tested in accordance with ASTM Performance Weathering Requirements. The PVC compound shall have successfully met the weathering requirements prescribed for six months at each climatic testing site prior to use in production of exterior-profile extrusions, when tested in accordance with ASTM Performance Weathering Requirements (TABLE 1).

## ASTM Specifications Met

- D256** - To determine Izod impact properties
- D618** – Practice for Conditioning Plastics for Testing
- D635** – Test Method for Rate of Burning and/or Extent and Time of Burning of Plastics in a Horizontal Position D638 - To determine tensile properties
- D648** - To determine heat distortion temperature
- D696** – Test Method for Coefficient of Linear Thermal Expansion of Plastics Between 030°C and 30°C with a Vitreous Silica Dilatometer
- D790** - To determine flexural properties
- D792** - To determine specific gravity
- D883** – Terminology Relating to Plastics
- D1435** – Practice for Outdoor Weathering of Plastics
- D1600** Terminology for Abbreviated Terms Relating to Plastics
- D1784** – Specification for Rigid Poly (Vinyl Chloride) (PVC) Compounds and Chlorinated Poly (Vinyl Chloride) (CPVC) Compounds
- D1898** – Practice for Sampling of Plastics
- D2240** - To determine Shore hardness values
- D2244** – Practice for Calculation of Color Tolerances and Color Differences from Instrumentally Measured Color Coordinates
- D2565** – Practice for Xenon-Arc Exposure of Plastics Intended for Outdoor Applications
- D4216** – Material Class Number 1–21333–22. To establish Cell Classification of PVC material. Illusions compounds have higher cell classification because one or more properties are superior to those used in standard acceptable compounds
- D4226** – Test Methods for Impact Resistance of Rigid Poly-(Vinyl Chloride) (PVC) Building Products
- D4726** – Specification for Rigid Poly(Vinyl Chloride) (PVC) Exterior-Profile Extrusions Used for Assembled Windows and Doors
- D7032** – Standard specification for establishing performance ratings for wood-plastic composite and plastic lumber deck boards, stair treads, guards, and handrails.
- E-84-04** - Used to determine the flame spread value of PVC material; Illusions burn rate is significantly lower than allowed value

## Quality Assurance

Illusions Vinyl Fence Products are run through dimensional tests at the startup of a production run and every two hours thereafter including flattening, extrusion quality, impact resistance, warp, color comparison with standard color samples, capstock thickness, and bond testing will be done at the startup of a production and once per shift thereafter with a minimum of two tests per 24 hours of production.

**TABLE 1 - Required Exposures for PVC Extrusions - In Process**

Color of PVC Extrusions	Exposure Climate	Required Exposure Times, Months*
White	hot, dry (Phoenix, AZ)	6 and 12
	hot, humid (Miami, FL)	6 and 12
	northern temperate	6 and 12
Any other color	hot, dry (Phoenix, AZ)	6, 12 and 24
	hot, humid (Miami, FL)	6, 12 and 24
	northern temperate	6, 12 and 24

\*It is recommended that separate specimens be used for each exposure time.

THESE ARE THE RESULTS FROM AN ACCELERATED WEATHER TESTING CHAMBER IN LABORATORY CONDITIONS

## The Illusions® Vinyl Fence Advantage

This test is run according to ASTM Standard G-155, Cycle #1. All Illusions® Vinyl Fence Product is guaranteed to be made from 100% Pure Virgin Vinyl and assembled according to ASTM F964. Please note the difference in color retention and be assured, Illusions® Vinyl Fence will have uniformed color and be free of any visual surface or structural changes such as: peeling, chipping, cracking, flaking, or pitting after weathering.

Be assured! Insist on *Illusions® Vinyl Fence* Products.



**Competitor:**  
**450 Hrs.**  
(4-5 Years)



**WOW!**  
THAT WOULD  
COST A FORTUNE  
IN RE-INSTALLS!



**Illusions®:**  
**1000 Hrs.**  
(10-11 Years)

# Need Vinyl Railing Too?

*Looking for the perfect railing to match your brand new Illusions Vinyl Fence?*

From the tallest skyscraper to your front porch, ICC-ES AC174 compliant Illusions Vinyl Railing System is the perfect choice for your next railing installation. Made of 100% Pure Virgin Vinyl, all styles are available in all Classic Color options.

*(Ask your local Illusions dealer for the Illusions Vinyl Railing brochure to find out more.)*



[www.illusionsvinylrailing.com](http://www.illusionsvinylrailing.com)

# Illusions<sup>®</sup>

Vinyl Fence

[www.illusionsfence.com](http://www.illusionsfence.com)



- Beautify Your Outdoor Living Space
- Enjoy Stylish Privacy & Security
- Increase Your Property Value
- 100% Pure Virgin Vinyl - Fence
- Available in all Classic Color options

[www.illusionsfence.com](http://www.illusionsfence.com)

Illusions products are sold wholesale to the trade.  
Contact your local fence company for pricing.



Professional Fence Dealer

FRONT: V700-4 in Classic White | BACK: V3700-6 in Classic White